

SOLENOID DIAPHRAGM DOSING PUMP GAMMA/ L FROM ProMInent.
MORE CONTROL, MORE DISPLAY, MORE APPLICATION VERSATILITY.



NEW ROUTE



ProMInent®

**GAMMA/ L – THE DOSING PUMPS WITH INTELLIGENCE.
MORE CONTROL VERSATILITY – LESS OPERATOR STRESS.**

i Large illuminated LCD display - clear and visible even from awkward angles.

i Unique in this capacity class: the feed rate can be displayed in l/h or in US-gal/h. This allows precise and simple adjustment.

i All display information can be called up and viewed rapidly via a menu system.

i A field bus interface (Profibus DP) is currently under development. This will allow pumps to be integrated into complex systems with central computer control.





gamma/ L is the right choice wherever digital dosing reproducibility and simple operation is required



Greater flexibility of control and applications, clear and simple to

At the same time a comprehensive display makes operation simpler. Large text and continuous illumination means easy viewing of all settings and measured variables, even under difficult lighting conditions.

The high level pump control provides the best conditions for "remote controlled" applications, for instance via an analogue standard signal 0/4-20 mA with user selected assignment of the pump frequency to the control

NEW ACCESS

operate – these are the advantages of the new gamma/ L pump series. These performance characteristics are made possible by the inclusion of a new enhanced micro-processor controller. This provides the basis for significantly increased user and display options, more process-specific control variants and even more flexibility for external pump control.

Naturally, quantity settings are displayed too: gamma/ L is the first calibratable pump in this capacity class to display the feed rate in l/h or optionally in US-gal/h – even in the standard version. This means simple and reliable recognition and monitoring of the dosing quantity. Pump programming is also carried out via the display. Plain text operating instructions ensure convenient control settings adjustment.

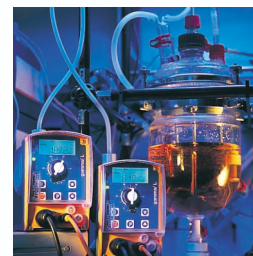

gamma/ L means flexibility, the pumps can be adapted to a huge variety of processes, e.g. installation in scale model systems

signal. The contact controller detects excess or shortfall pulses and signals from the process automation systems. Therefore gamma/ L is suited to practically all control environments. Each control variant and each option can also be retrofitted at a later date.

GAMMA/ L – THE ALL-ROUNDER WITH ADDED TAILORING.



gamma/ L is available in five different liquid end materials: PP, PVC, poly-acrylic/PVC, PTFE and stainless steel. This means that these pumps can be adapted to practically any dosing fluids.



Even the feed rates of the gamma/ L series can be tailored to use. They encompass a capacity range of 0.74 to 32 l/h at back pressures of between 2 and 16 bar.



The broad capacity range, the versatility of the pump controller and the extensive choice of materials guarantees that pumps can be chosen to meet precise application requirements in practically all conditions.



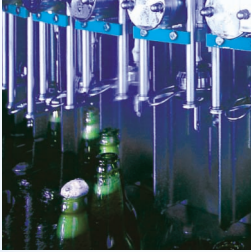

Micro-organism free beverages – gamma/ L meters e.g. cleaning fluids and disinfectants

gamma/ L is at home wherever dosing precision is as important as accurate dosing reproducibility. For this reason it is already assured a place in many industries and sectors, for instance in the chemical industry, for

research and development and in trial systems and it will also perform well in the pharmaceutical industry, in the food and drinks industry and in breweries. It is also ideally suited to important applications such as water

numerous additional application areas - an all-rounder like gamma/ L knows no bounds.

NEW CHOICE

the metering of aggressive chemicals. Its precision is an ideal prerequisite for use in

treatment and waste water treatment, whereas tackling microorganisms in swimming pools offers



Series precision – the new gamma/ L

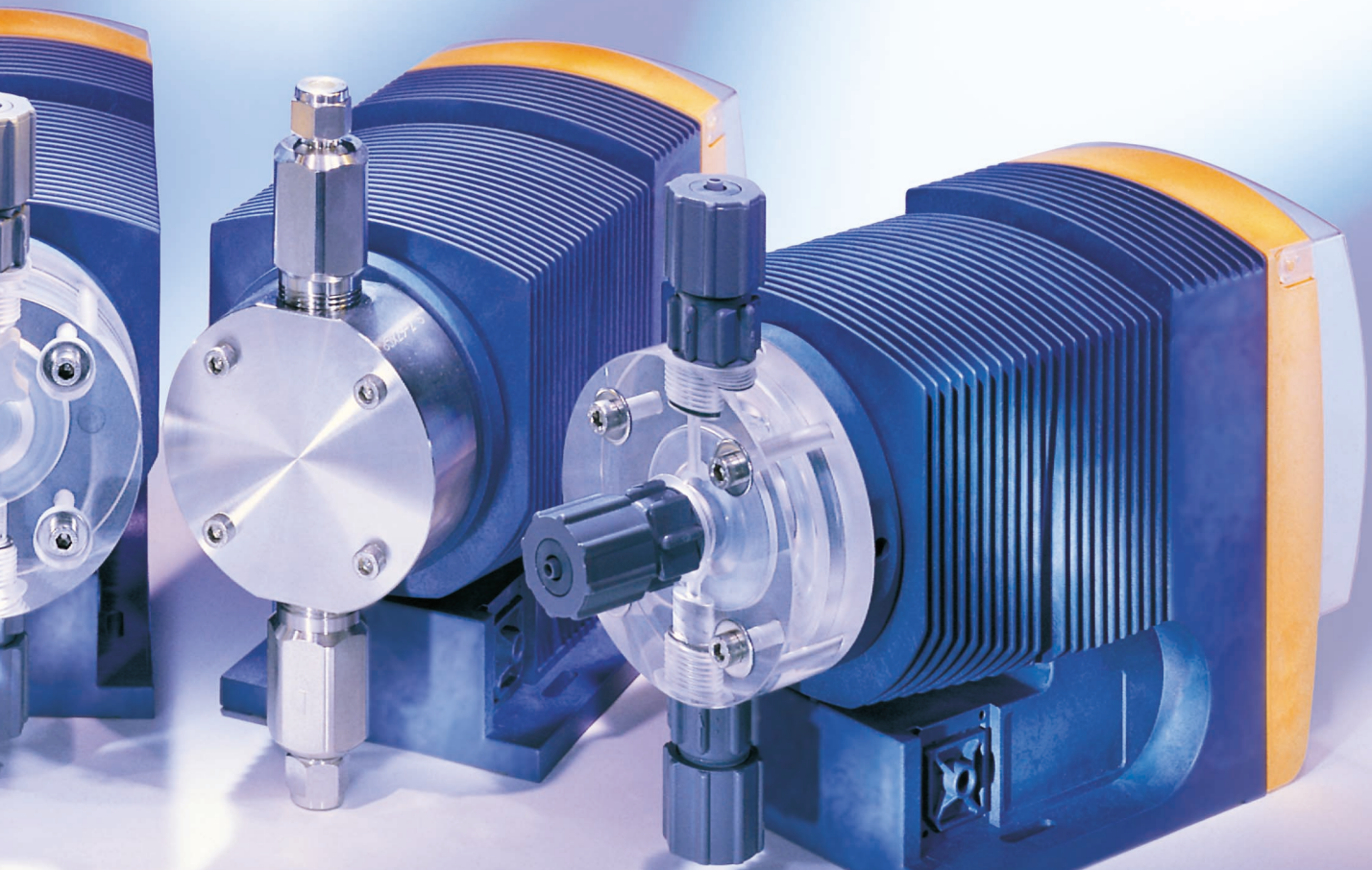

GAMMA/ L IN DETAIL: FUNCTIONS, FACTS AND FIGURES.



Control and reliability – the dual advance warning and warning safety system warns of any irregularity in good time.



The green light indicates failure-free operation. All functions correspond to the pre-set programme. There is nothing standing in the way of precision dosing.



Advance warning system. In good time the sensors indicate any discrepancy between the programme and performance, or when the dosing liquid is due to be renewed.



Red is the warning light. Urgent action is now required. The pump has registered a function failure. It automatically shuts down and a corresponding failure message appears in the display.

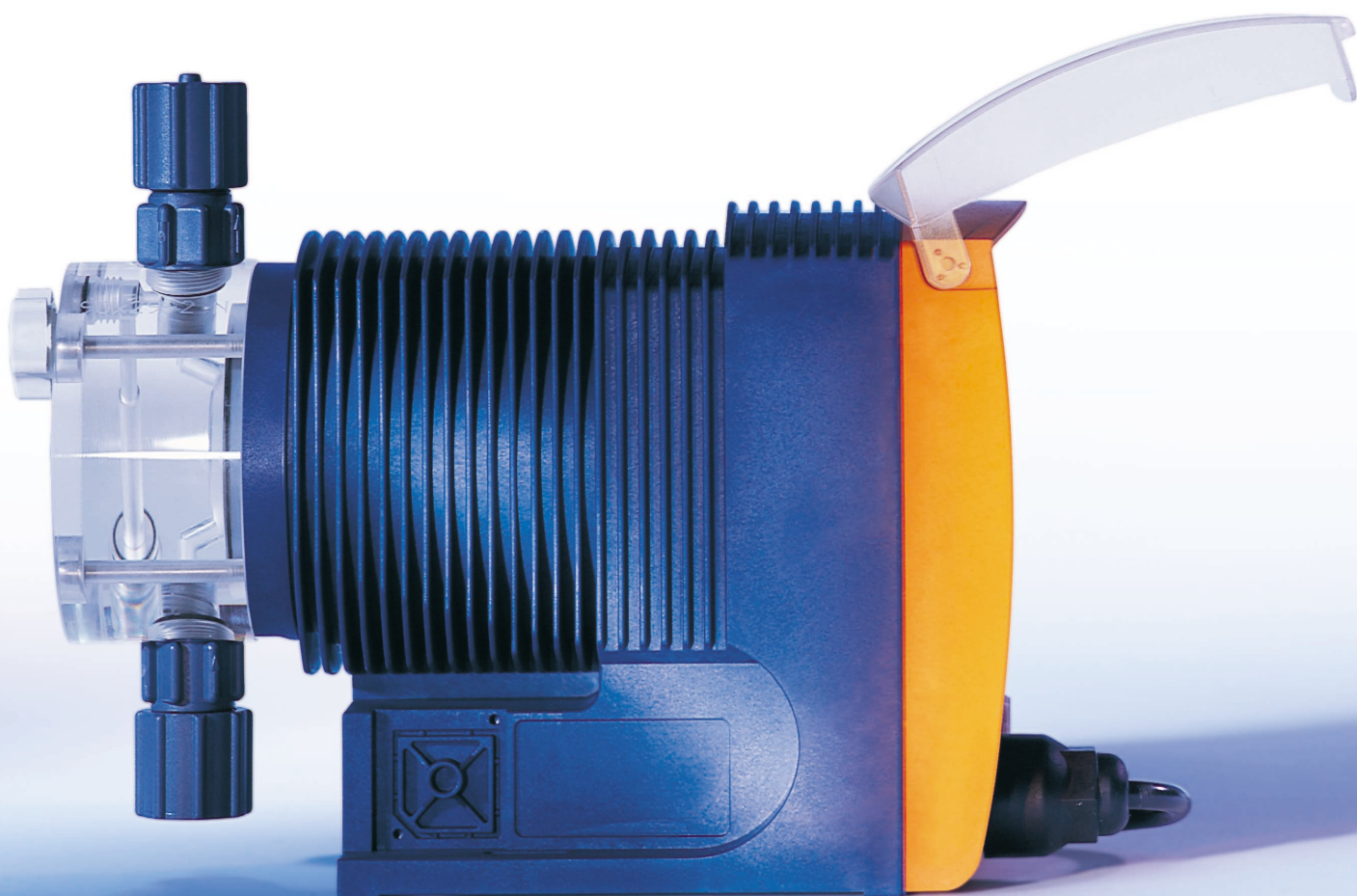

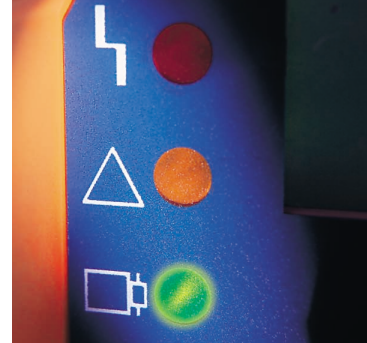
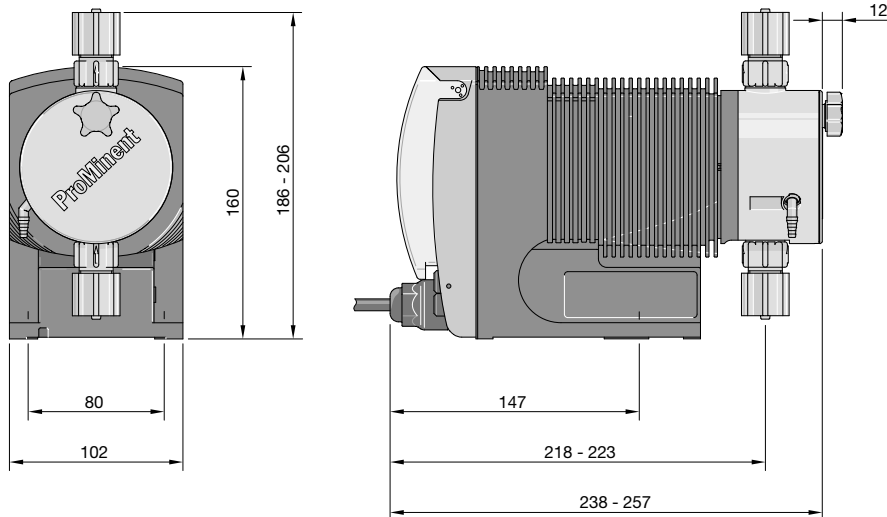

NEW CONTROL

gamma/L is characterised by a robust and durable drive technology. The single moving component is an almost maintenance-free solenoid inductor.

The feed rate is set by varying the stroke frequency of the inductor (from 0 to 180 strokes/min.) or stroke length (recommended 30 to 100 %).

If the stroke length is adjusted more than $\pm 10\%$ the electronics indicate that re-calibration is required. Optimum precision is also guaranteed by the dosing

monitor. The number of tolerated failure strokes (for instance when dosing gaseous liquids) can be set to between 1 and 125.

Pump type gamma/L	Pump capacity at maximum back pressure			Pump capacity at average back pressure			Stroke frequency strokes/ min.	Connector dimensions o \varnothing x i \varnothing mm	Suction lift* mWG	Delivery weight PP, NP, PC, TT-SS approx. kg
	bar	l/h	ml/ stroke	bar	l/h	ml/ stroke				
GALa 1000	10	0.74	0.07	5	0.82	0.08	180	6/4	5	4.3 – 5.0
GALa 1601	16	1.1	0.10	8	1.4	0.13	180	6/4	5	4.3 – 5.0
GALa 1602	16	2.1	0.19	8	2.5	0.24	180	6/4	5	4.3 – 5.0
GALa 1005	10	4.4	0.41	5	5.0	0.46	180	8/5	5	4.5 – 5.3
GALa 0708	7	7.1	0.66	3.5	8.4	0.78	180	8/5	3	4.5 – 5.3
GALa 0413	4	12.3	1.14	2	14.2	1.31	180	8/5	2	4.5 – 5.3
GALa 0220	2	19.0	1.76	1	20.9	1.94	180	12/9	2	4.7 – 5.8
GALa 1605	16	4.1	0.38	8	4.9	0.45	180	8/5	4	4.5 – 5.3
GALa 1008	10	6.8	0.63	5	8.3	0.76	180	8/5	3	4.5 – 5.3
GALa 0713	7	11.0	1.02	3.5	13.1	1.21	180	8/5	3	4.5 – 5.3
GALa 0420	4	17.1	1.58	2	19.1	1.77	180	12/9	3	4.7 – 5.8
GALa 0232	2	32.0	2.96	1	36.2	3.35	180	12/9	2	5.1 – 6.6

* suction lift with filled liquid end and suction tube.

**SERIES SUCCESS:
PROMINENT® SOLENOID
DIAPHRAGM DOSING PUMPS**



**ProMinent®
mikro g/5**
capacity range:
up to 40 bar,
up to 1500 ml/h

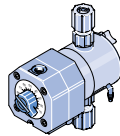

**ProMinent®
Pneumados**
capacity range:
up to 16 bar,
up to 15 l/h

**ProMinent®
gamma/ L**
capacity range:
up to 16 bar,
up to 32 l/h

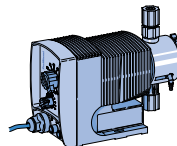
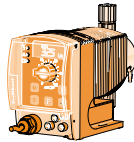

**ProMinent®
Beta®**
capacity range:
up to 16 bar,
up to 32 l/h

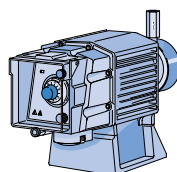

**ProMinent
EXtronic®**
capacity range:
up to 25 bar,
up to 60 l/h

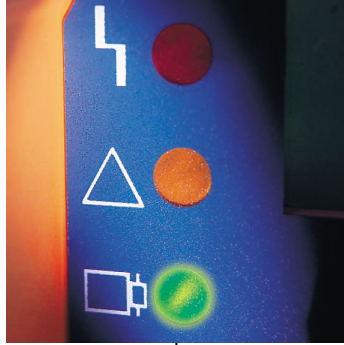

ROL

monitor. The number of tolerated failure strokes (for instance when dosing gaseous liquids) can be set to between 1 and 125.

Range gamma/ L	Electrical connection data
Drive	Low wear solenoid drive with microprocessor power control
Electrical connection	100-230 V, 50/60 Hz
Power	22 W mid power consumption at maximum stroke rate
Current consumption	0.4 A rated current at 230 V AC



PROMINENT EXPERIENCE – GAMMA/ L'S GLOBAL COMPANION.

Precise process
control with
ProMinent
assurance

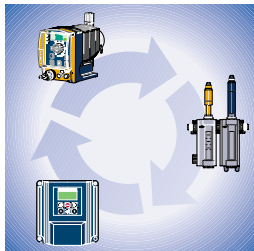

Reliable technical pro-
ducts that you can count
on, like gamma/ L, are

The ProMinent group is
active world-wide. Our
consultant technicians
can be found in all indu-
strial sectors. Wherever
you are, you can call on
our experience in fluid
control applications. We
will be glad to accom-

We invite you to take
advantage of our experi-
ence. The gamma/ L from
ProMinent, a name that
stands for sound advice,
rapid service and reliable
products around the
world.

NEW VALUE

only one side of the coin
for commercial success.
The other side is technical
support before and during
installation, advice on
new applications and pro-
ximity - around the world
where possible.

pany and advise you from
the initial concept to the
finished system, from the
first production run
through regular servicing
to potential system exten-
sions or retrofits. You can
count on specialists
whose aim is your success
and who believe that
customer proximity contri-
butes to that success.



All in hand:
The complete
accessory range for
individual applications

Addresses and delivery information may be obtained from the manufacturer:

ProMinent Dosiertechnik GmbH
Im Schuhmachergewann 5-11
D-69123 Heidelberg
Postfach 10 17 60 · D-69007 Heidelberg
Phone: +49 (6221) 842-0
Fax: +49 (6221) 842-419
info@prominent.de · www.prominent.de